

THE INFORMATION CONTAINED IN THIS DRAWING IS THE SOLE PROPERTY OF BELL-EVERMAN, INC. ANY REPRODUCTION IN PART OR WHOLE WITHOUT THE WRITTEN PERMISSION OF BELL-EVERMAN, INC. IS PROHIBITED.

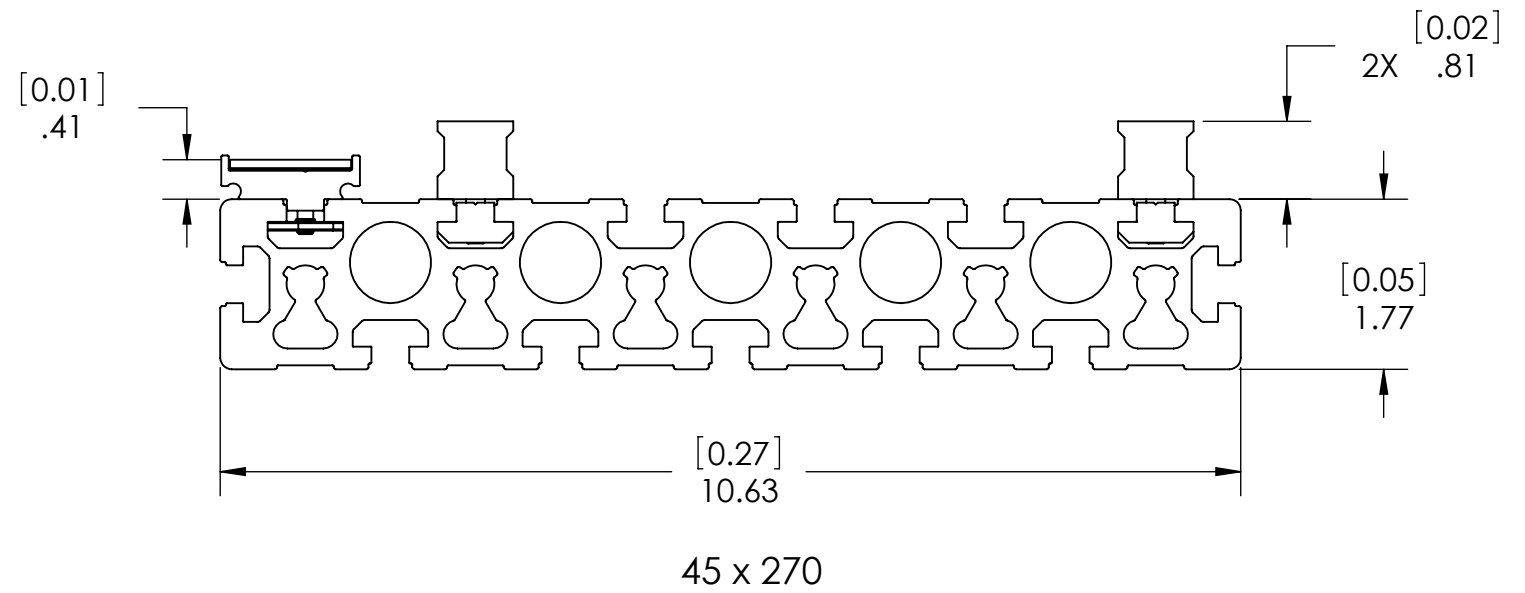

DIMENSIONS ARE IN INCHES UNLESS OTHERWISE SPECIFIED.  
 TOLERANCES ARE: DECIMAL INCH TOL: .X .1  
 .XX .01  
 .XXX .005  
 .XXXX .0005  
 ANGULAR: .5  
 BREAK CORNERS: .005-.020  
 FILLET RADII: .005-.020

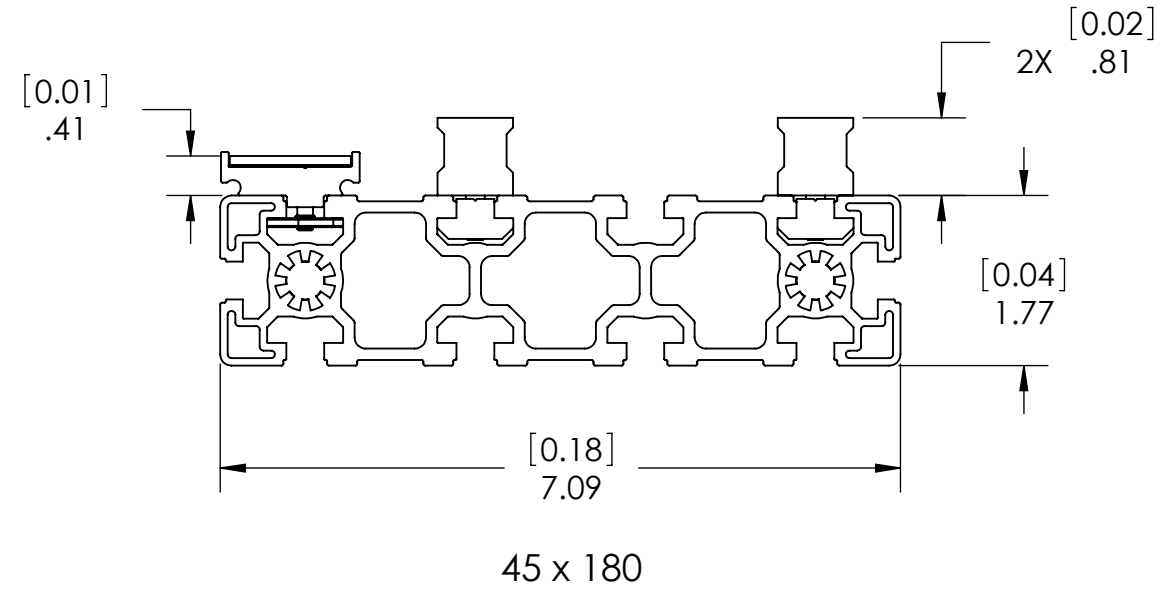
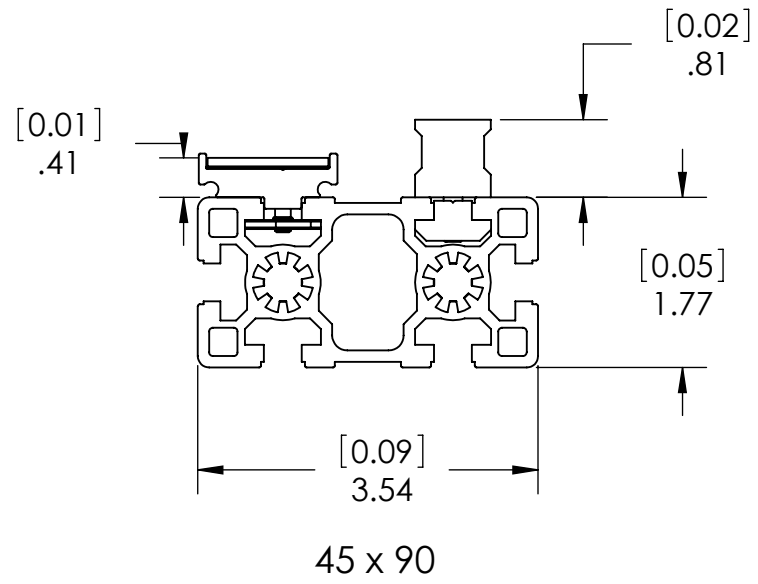

82 Aero Camino, Goleta, CA 93117  
 (805) 685-1029 FAX: (805) 685-6787

|            |             |                    |  |
|------------|-------------|--------------------|--|
| TITLE      |             | SBL-M 45mm CHASSIS |  |
| SIZE       | DRAWING NO. | REV                |  |
| B          |             | -                  |  |
| SCALE: 1:2 |             | SHEET 1 OF 1       |  |

THE INFORMATION CONTAINED IN THIS DRAWING IS THE SOLE PROPERTY OF BELL-EVERMAN, INC. ANY REPRODUCTION IN PART OR WHOLE WITHOUT THE WRITTEN PERMISSION OF BELL-EVERMAN, INC. IS PROHIBITED.

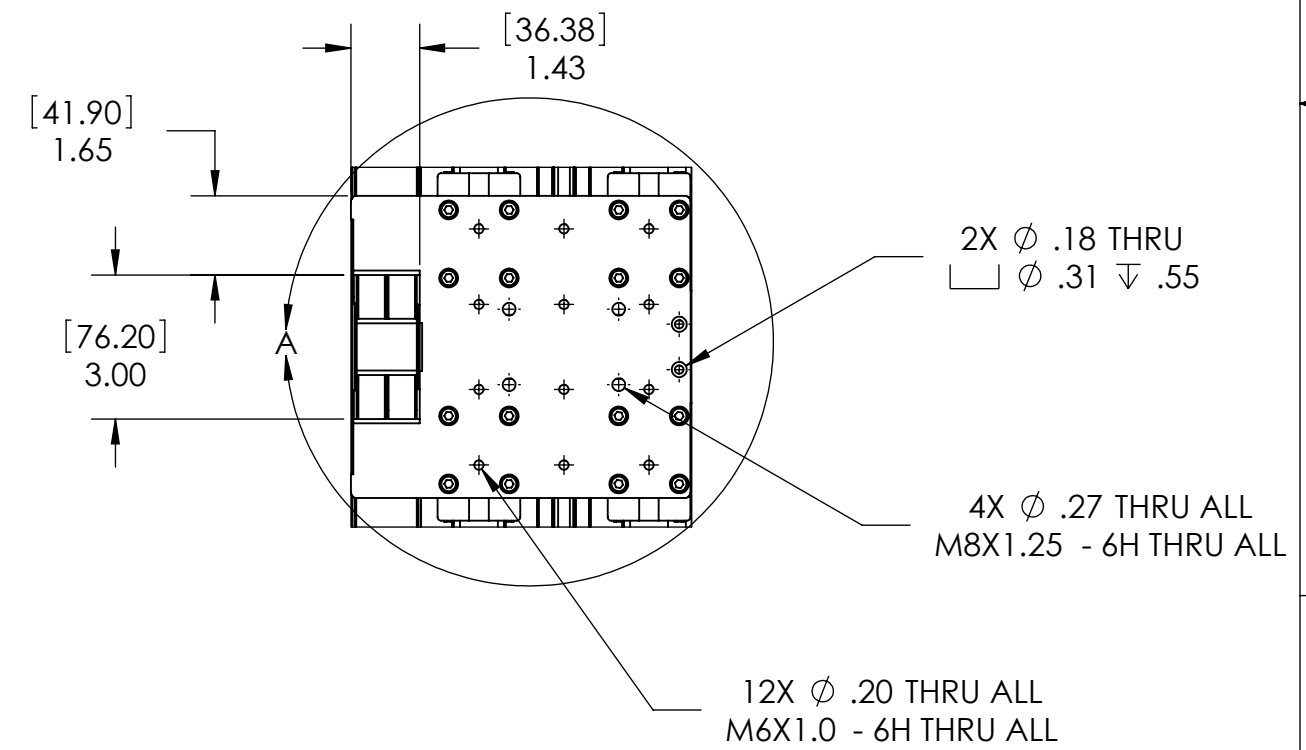
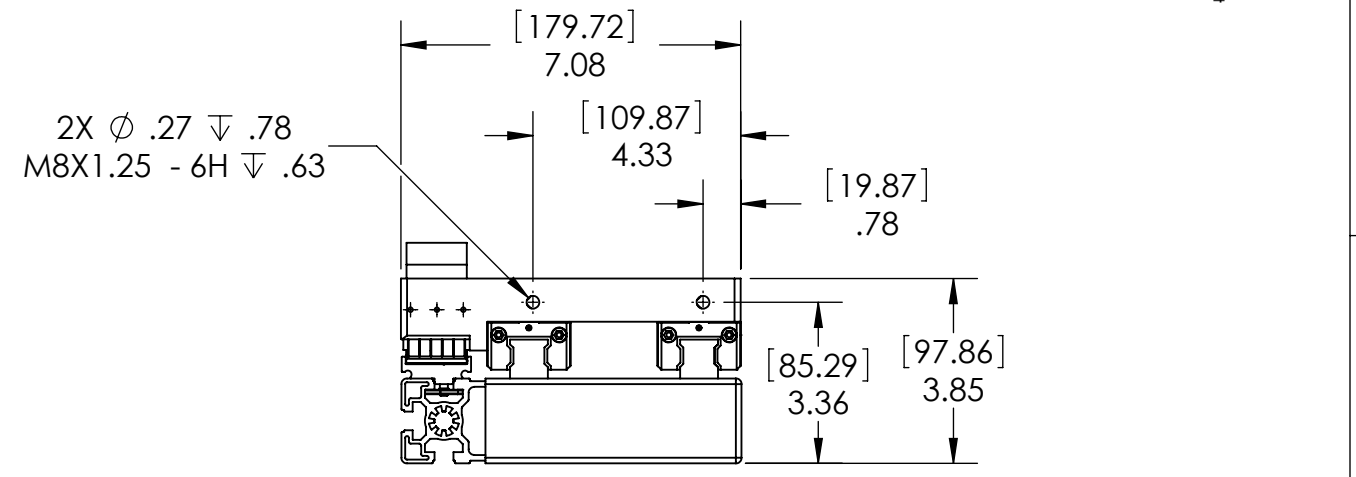
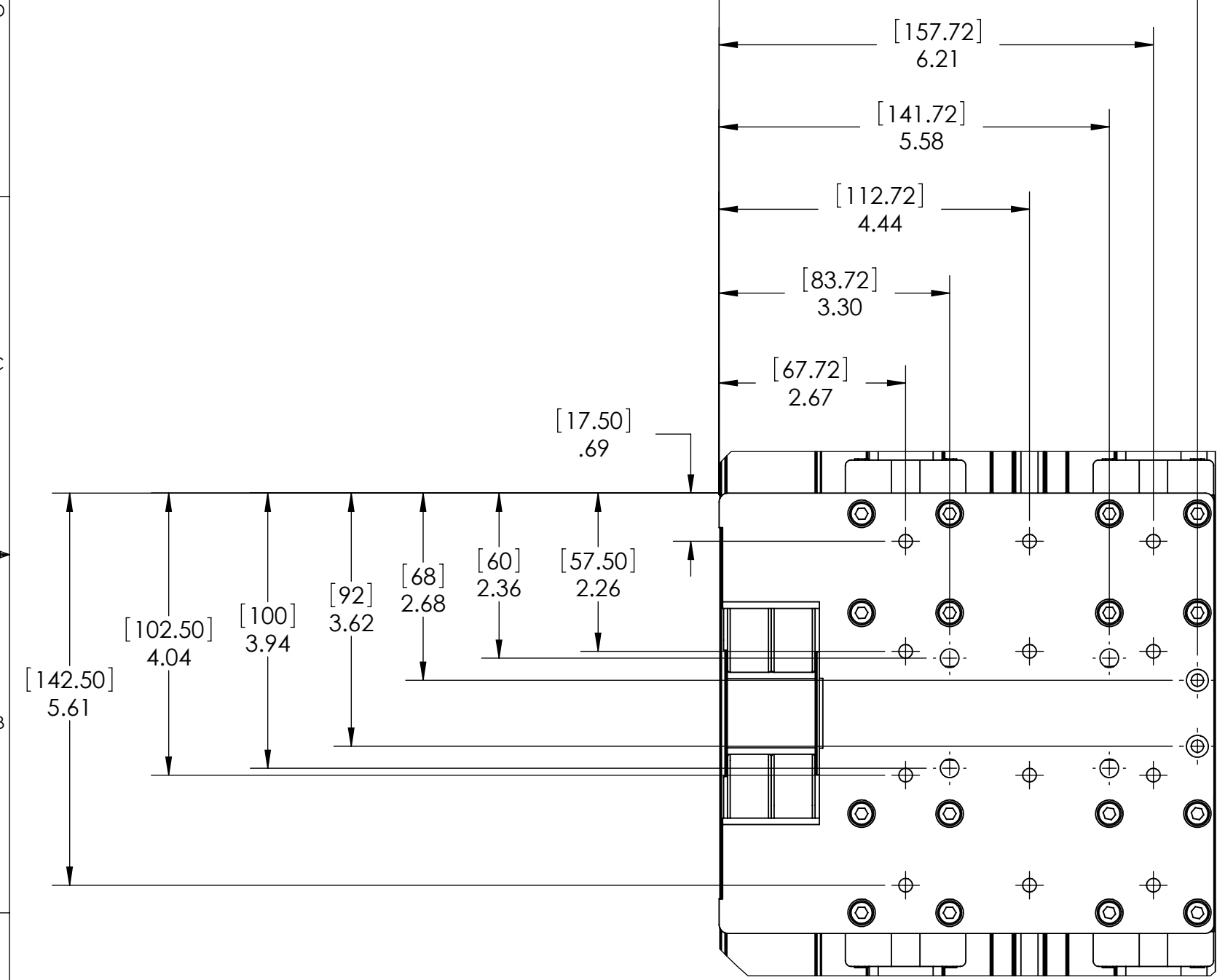
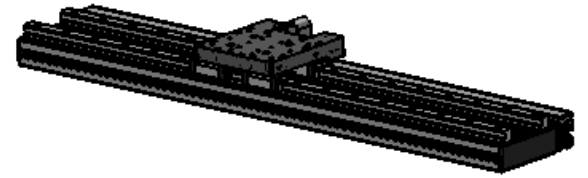

DETAIL A  
SCALE 1 : 2

|                              |             |  |              |
|------------------------------|-------------|--|--------------|
|                              |             | 82 Aero Camino, Goleta, CA 93117<br>(805) 685-1029 FAX: (805) 685-6787 |              |
| TITLE                        |             |  |              |
| <b>SBL-M 45x180 CARRIAGE</b> |             |  |              |
| SIZE                         | DRAWING NO. |  | REV          |
| B                            |             |  | -            |
| SCALE: 1:4                   |             |  | SHEET 1 OF 1 |

DIMENSIONS ARE IN INCHES UNLESS OTHERWISE SPECIFIED.  
 TOLERANCES ARE: DECIMAL INCH TOL: .X ±.1  
 .XX ±.01  
 .XXX ±.005  
 .XXXX ±.0005  
 ANGULAR: ±.5°  
 BREAK CORNERS: .005-.020  
 FILLET RADII: .005-.020

THE INFORMATION CONTAINED IN THIS DRAWING IS THE SOLE PROPERTY OF BELL-EVERMAN, INC. ANY REPRODUCTION IN PART OR WHOLE WITHOUT THE WRITTEN PERMISSION OF BELL-EVERMAN, INC. IS PROHIBITED.

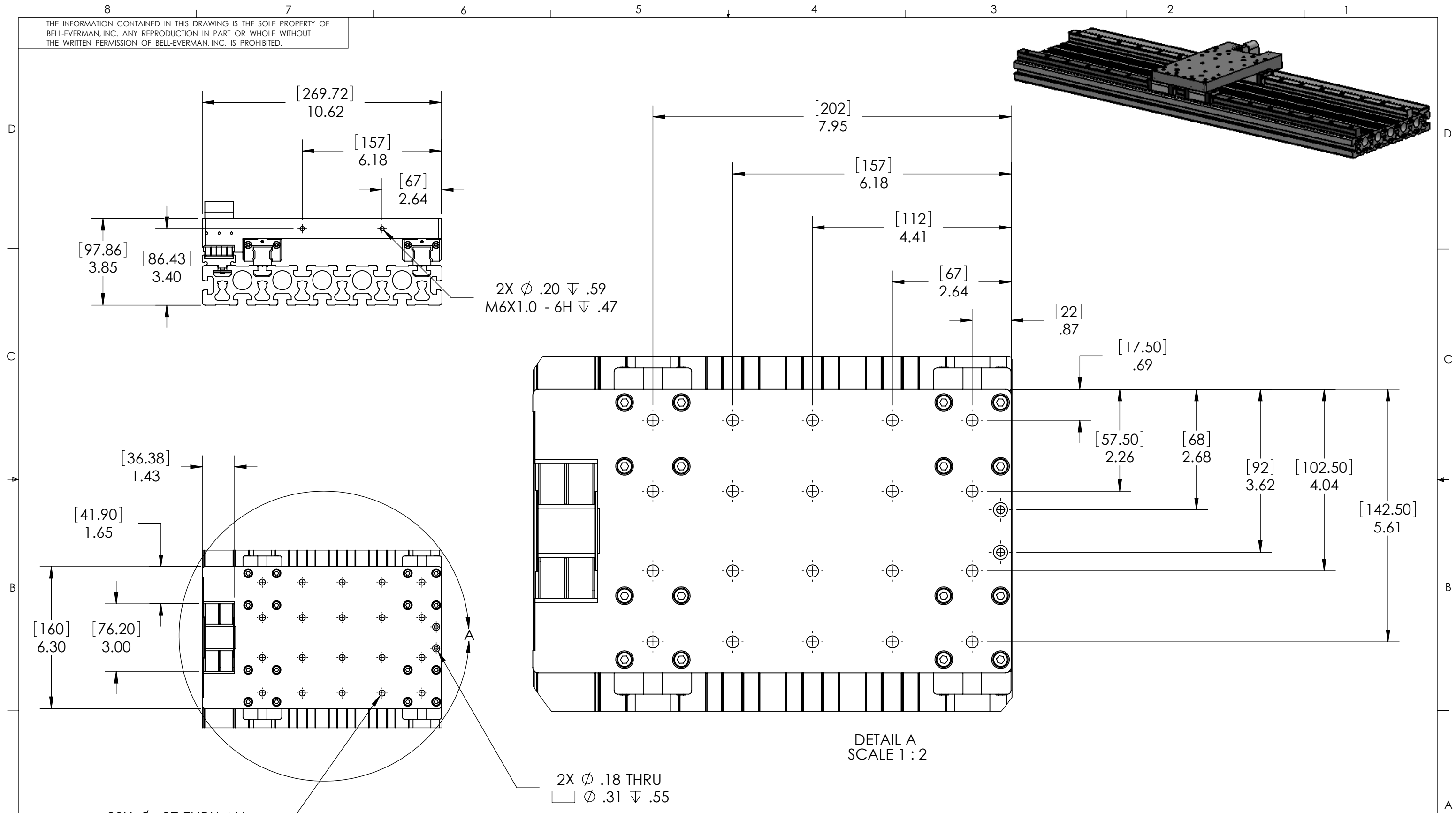
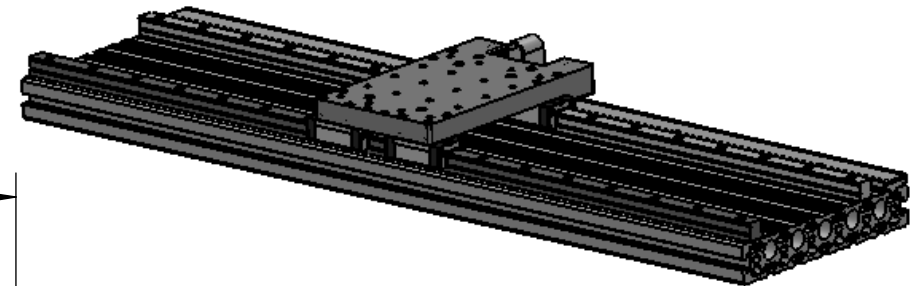



82 Aero Camino, Goleta, CA 93117  
(805) 685-1029 FAX: (805) 685-6787

|            |             |                       |        |
|------------|-------------|-----------------------|--------|
| TITLE      |             | SBL-M 45x270 CARRIAGE |        |
| SIZE       | DRAWING NO. | REV                   |        |
| B          |             | -                     |        |
| SCALE: 1:4 |             | SHEET                 | 1 OF 1 |

DIMENSIONS ARE IN INCHES UNLESS OTHERWISE SPECIFIED.  
TOLERANCES ARE: DECIMAL INCH TOL: .X ±.1  
.XX ±.01  
.XXX ±.005  
BREAK CORNERS: .005-.020  
.XXXX ±.0005  
FILLET RADII: .005-.020

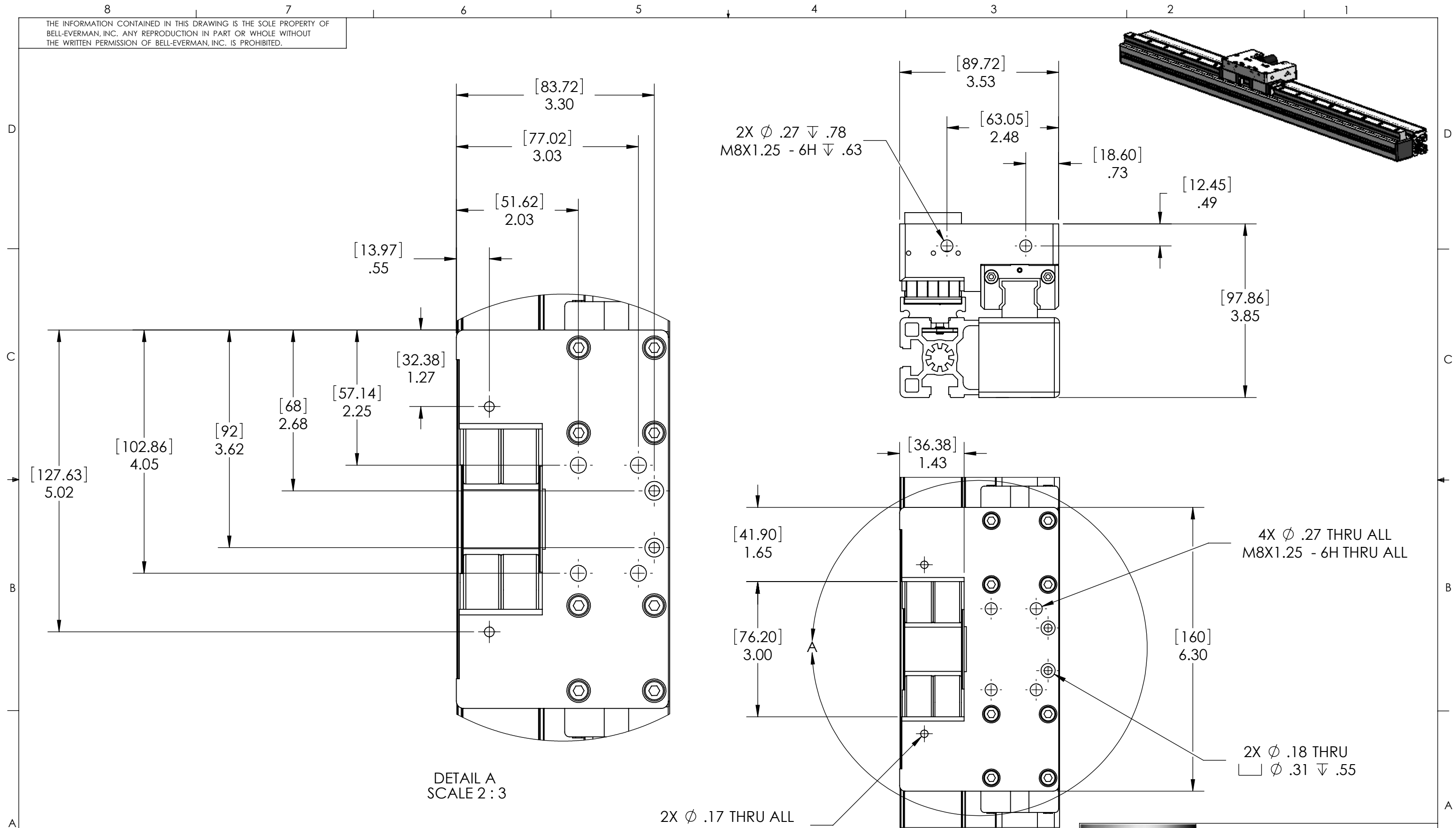
THE INFORMATION CONTAINED IN THIS DRAWING IS THE SOLE PROPERTY OF BELL-EVERMAN, INC. ANY REPRODUCTION IN PART OR WHOLE WITHOUT THE WRITTEN PERMISSION OF BELL-EVERMAN, INC. IS PROHIBITED.



|   |             |  |          |
|---|-------------|--|----------|
|  |             | 82 Aero Camino, Goleta, CA 93117<br>(805) 685-1029 FAX: (805) 685-6787 |          |
| TITLE<br><b>SBL-M 45x90 CARRIAGE</b>  |             |  |          |
| SIZE<br>B   | DRAWING NO. |  | REV<br>- |
| SCALE: 1:2  |             | SHEET 1 OF 1   |          |

DIMENSIONS ARE IN INCHES UNLESS OTHERWISE SPECIFIED.  
 TOLERANCES ARE: DECIMAL INCH TOL: .X ±.1  
 .XX ±.01  
 .XXX ±.005  
 .XXXX ±.0005  
 ANGULAR: ±.5°  
 BREAK CORNERS: .005-.020  
 FILLET RADII: .005-.020



THE INFORMATION CONTAINED IN THIS DRAWING IS THE SOLE PROPERTY OF BELL-EVERMAN, INC. ANY REPRODUCTION IN PART OR WHOLE WITHOUT THE WRITTEN PERMISSION OF BELL-EVERMAN, INC. IS PROHIBITED.

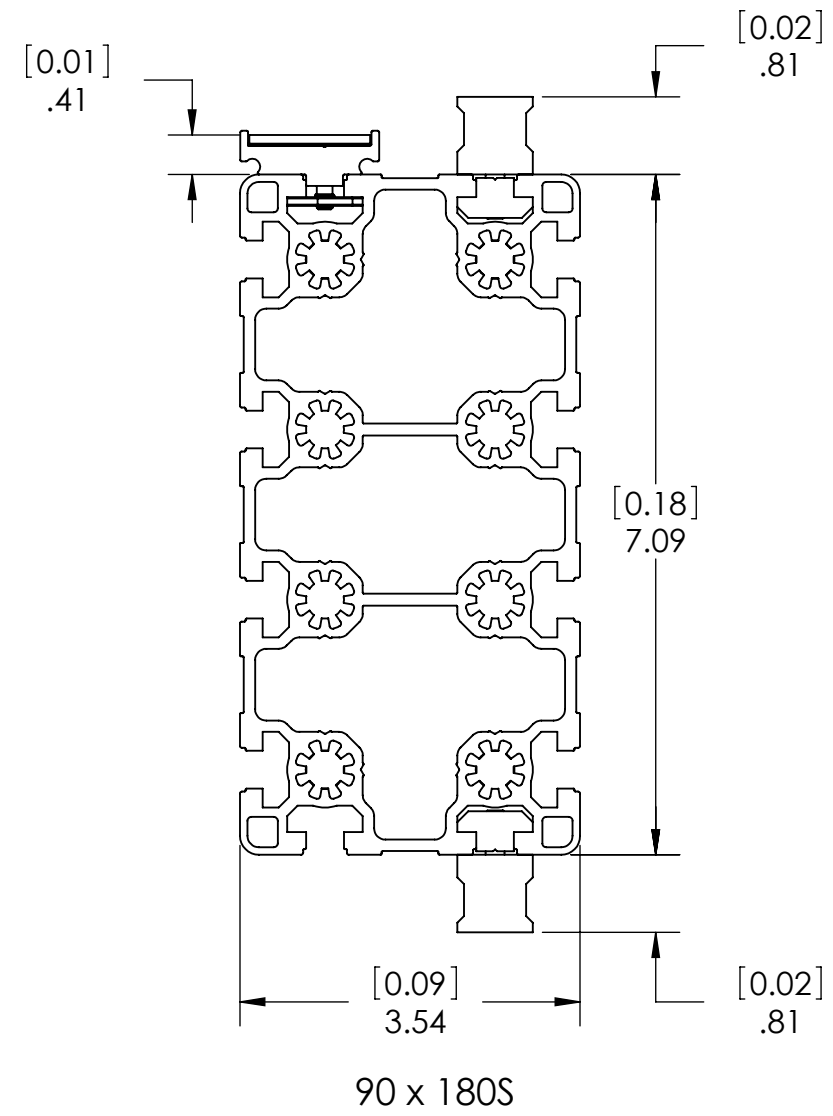
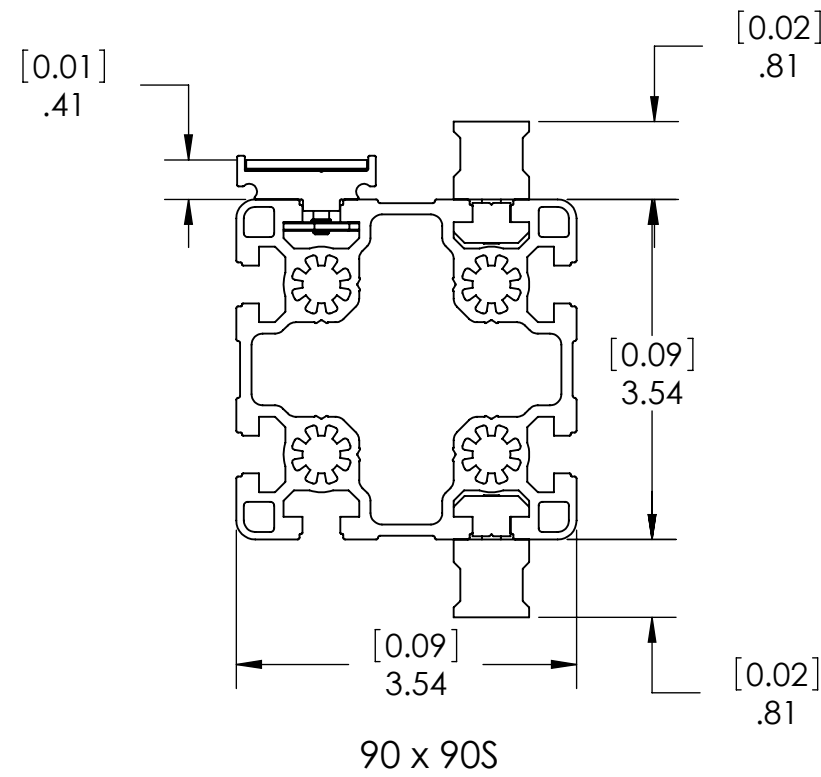
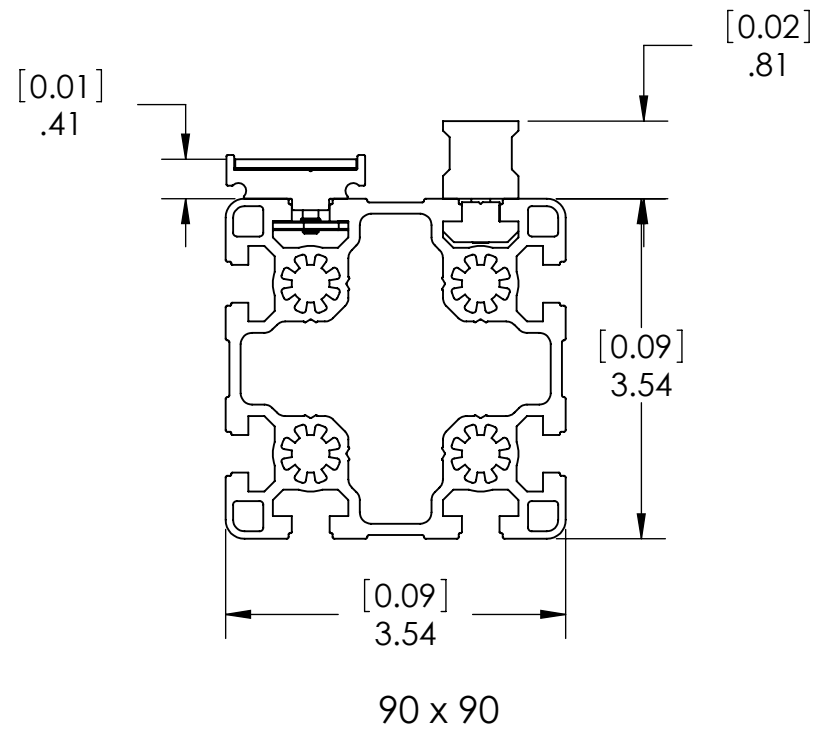

DIMENSIONS ARE IN INCHES UNLESS OTHERWISE SPECIFIED.  
 TOLERANCES ARE: DECIMAL INCH TOL: X .1  
 .XX .01  
 .XXX .005  
 .XXXX .0005  
 ANGULAR: .5  
 BREAK CORNERS: .005-.020  
 FILLET RADII: .005-.020



82 Aero Camino, Goleta, CA 93117  
 (805) 685-1029 FAX: (805) 685-6787

|                    |             |              |
|--------------------|-------------|--------------|
| TITLE              |             | REV          |
| SBL-M 90mm CHASSIS |             |              |
| SIZE               | DRAWING NO. | SHEET 1 OF 1 |
| B                  |             |              |
| SCALE: 1:2         |             |              |

THE INFORMATION CONTAINED IN THIS DRAWING IS THE SOLE PROPERTY OF BELL-EVERMAN, INC. ANY REPRODUCTION IN PART OR WHOLE WITHOUT THE WRITTEN PERMISSION OF BELL-EVERMAN, INC. IS PROHIBITED.

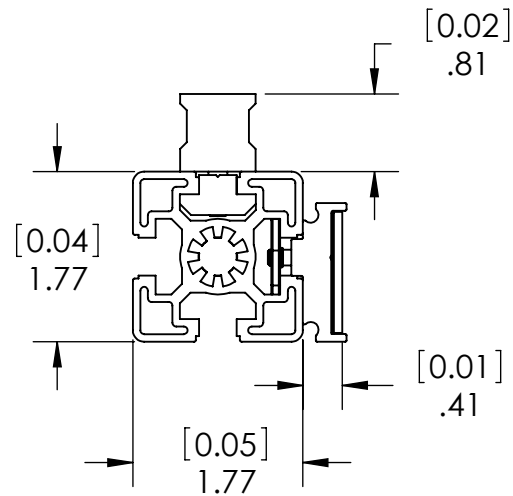

45 x 45

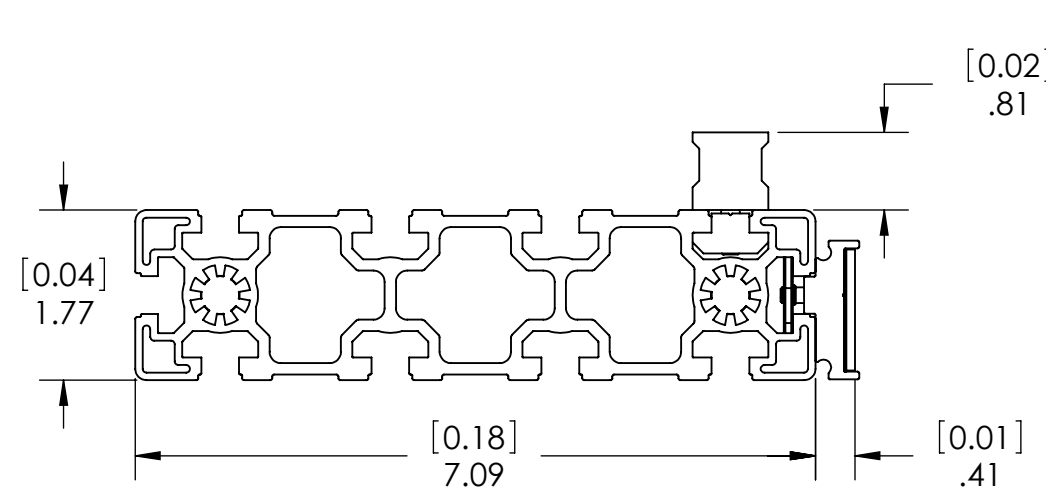

45 x 180

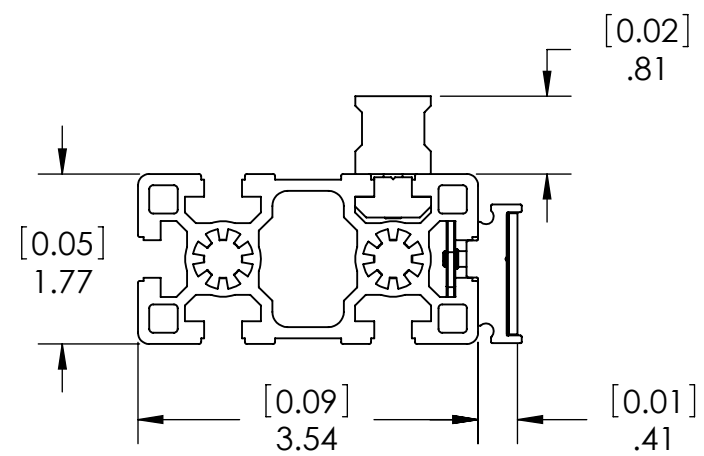

45 x 90

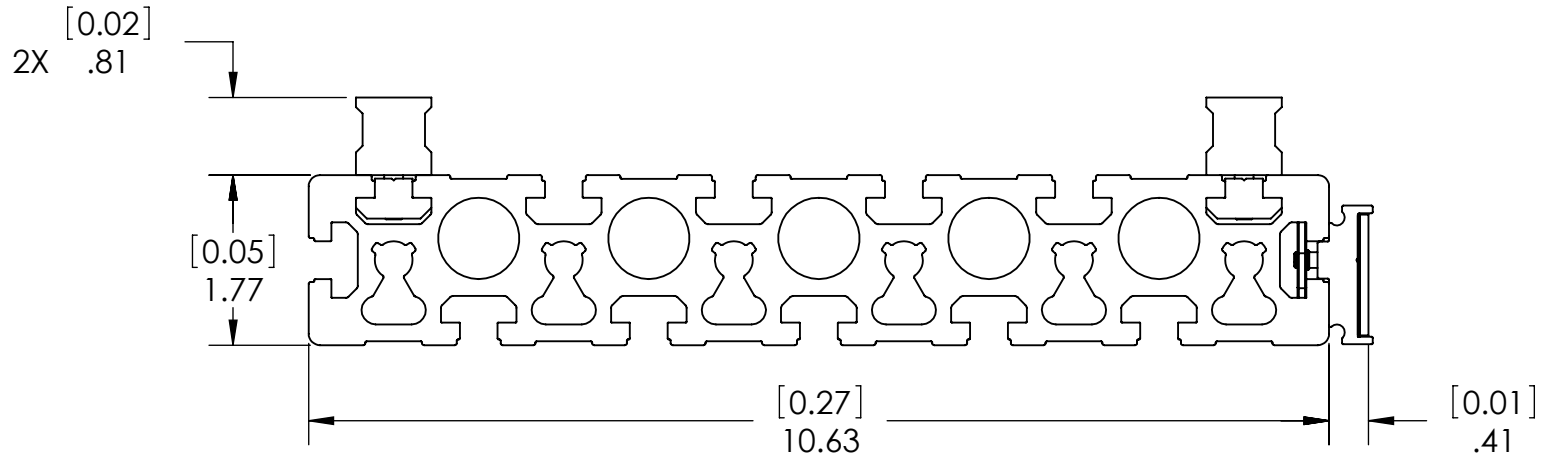

45 x 270

DIMENSIONS ARE IN INCHES UNLESS OTHERWISE SPECIFIED.  
 TOLERANCES ARE: DECIMAL INCH TOL: X .1  
 .XX .01  
 .XXX .005  
 .XXXX .0005  
 ANGULAR: .5  
 BREAK CORNERS: .005-.020  
 FILLET RADII: .005-.020

|   |             |  |          |
|---|-------------|--|----------|
|  |             | 82 Aero Camino, Goleta, CA 93117<br>(805) 685-1029 FAX: (805) 685-6787 |          |
| TITLE<br><b>SBL-M WRAP SERIES</b>   |             |  |          |
| SIZE<br>B   | DRAWING NO. |  | REV<br>- |
| SCALE: 1:2  |             | SHEET 1 OF 1   |          |